

FramePro[®] 651 Framing Nailer



Parts Reference Guide



Repair Kit
YK0360

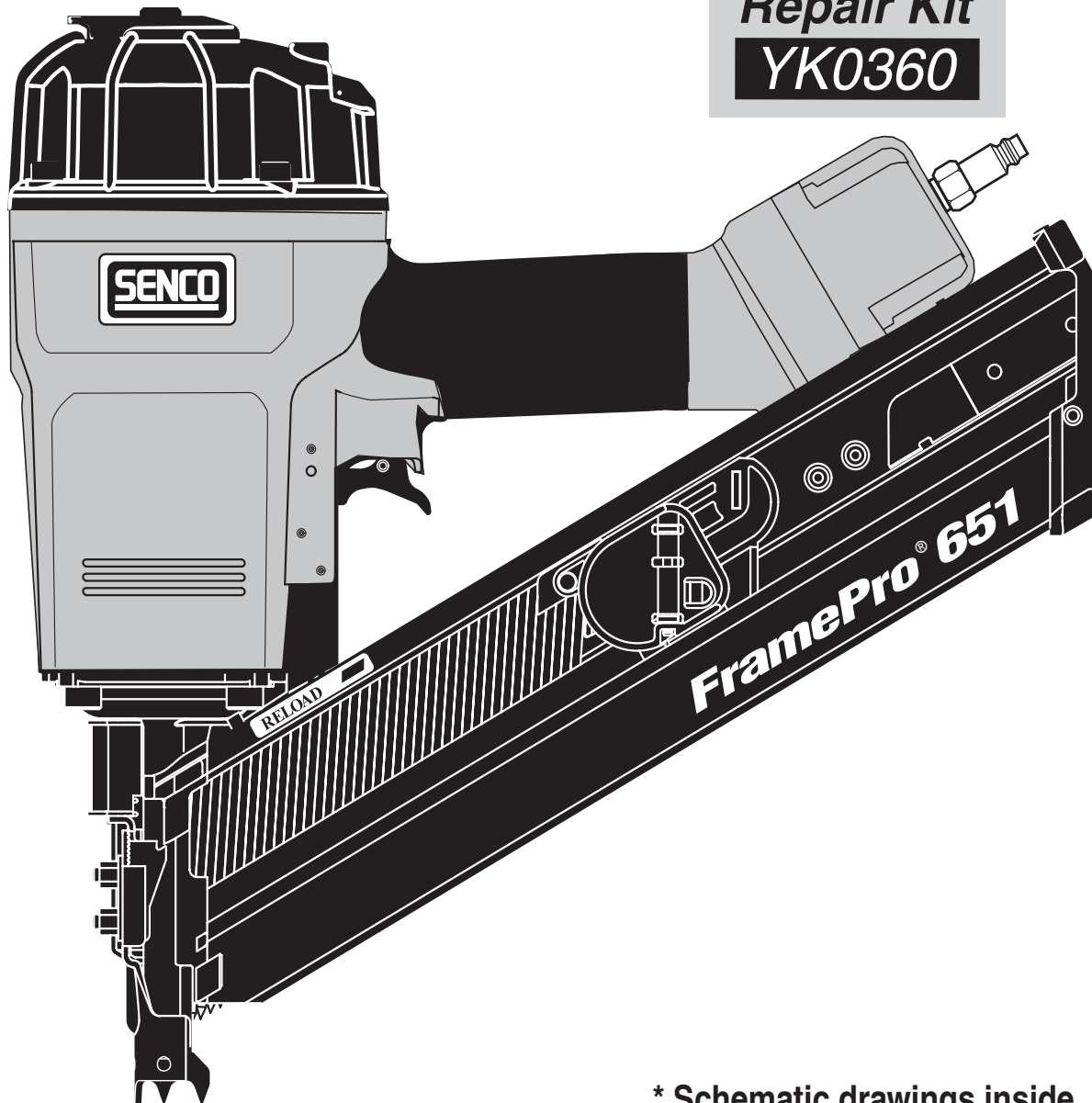

* Schematic drawings inside

Senco Products, Inc.
8485 Broadwell Rd.
Cincinnati, Ohio 45244

Questions? Comments? call SENCO's toll-free Action-line:
1-800-543-4596 (North & South America only)
or e-mail: toolprof@senco.com

Visit our Website: www.senco.com

FramePro® 651

SENCO®

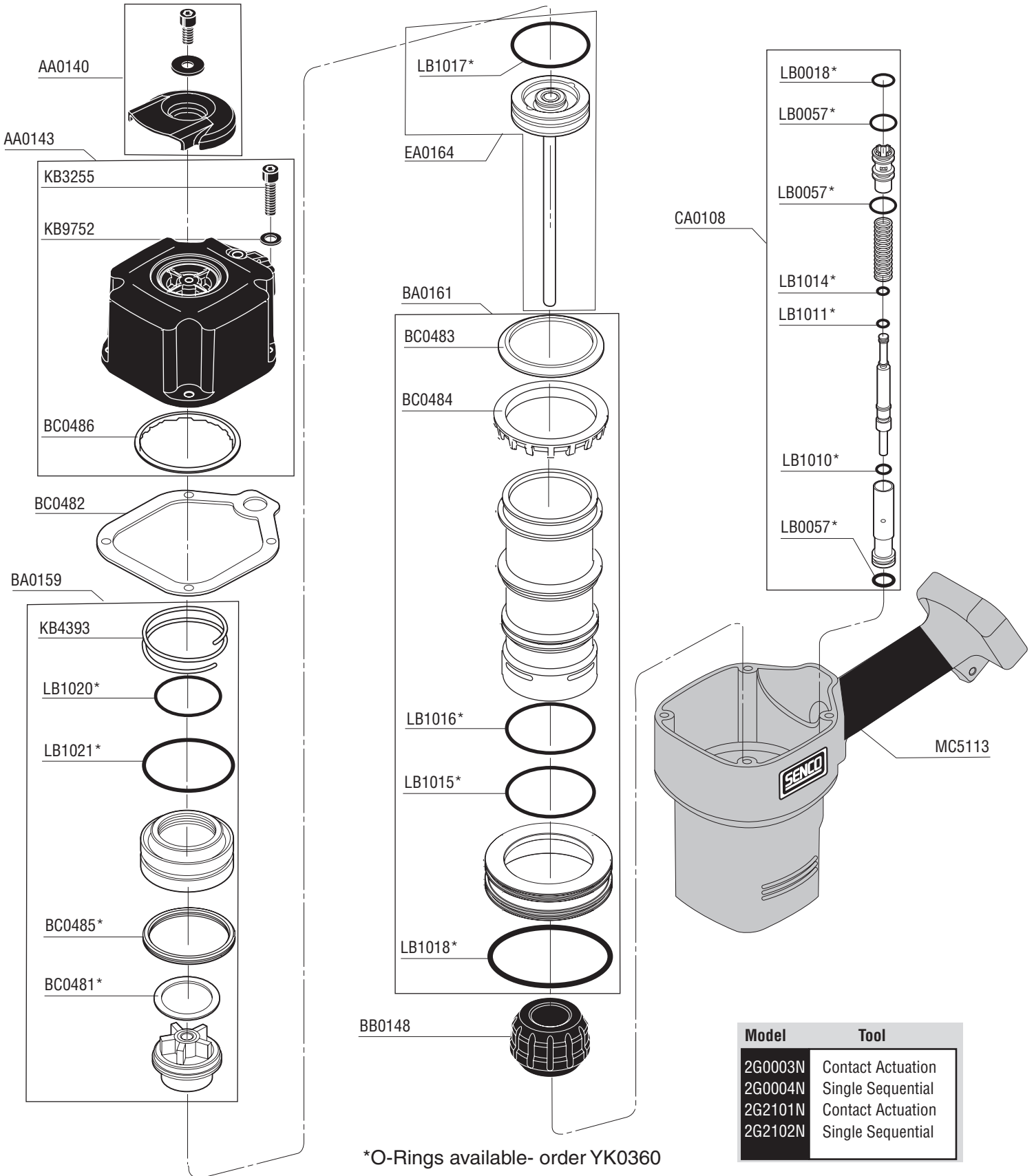

*O-Rings available- order YK0360

Model	Tool
2G0003N	Contact Actuation
2G0004N	Single Sequential
2G2101N	Contact Actuation
2G2102N	Single Sequential



FramePro® 651

SENCO®

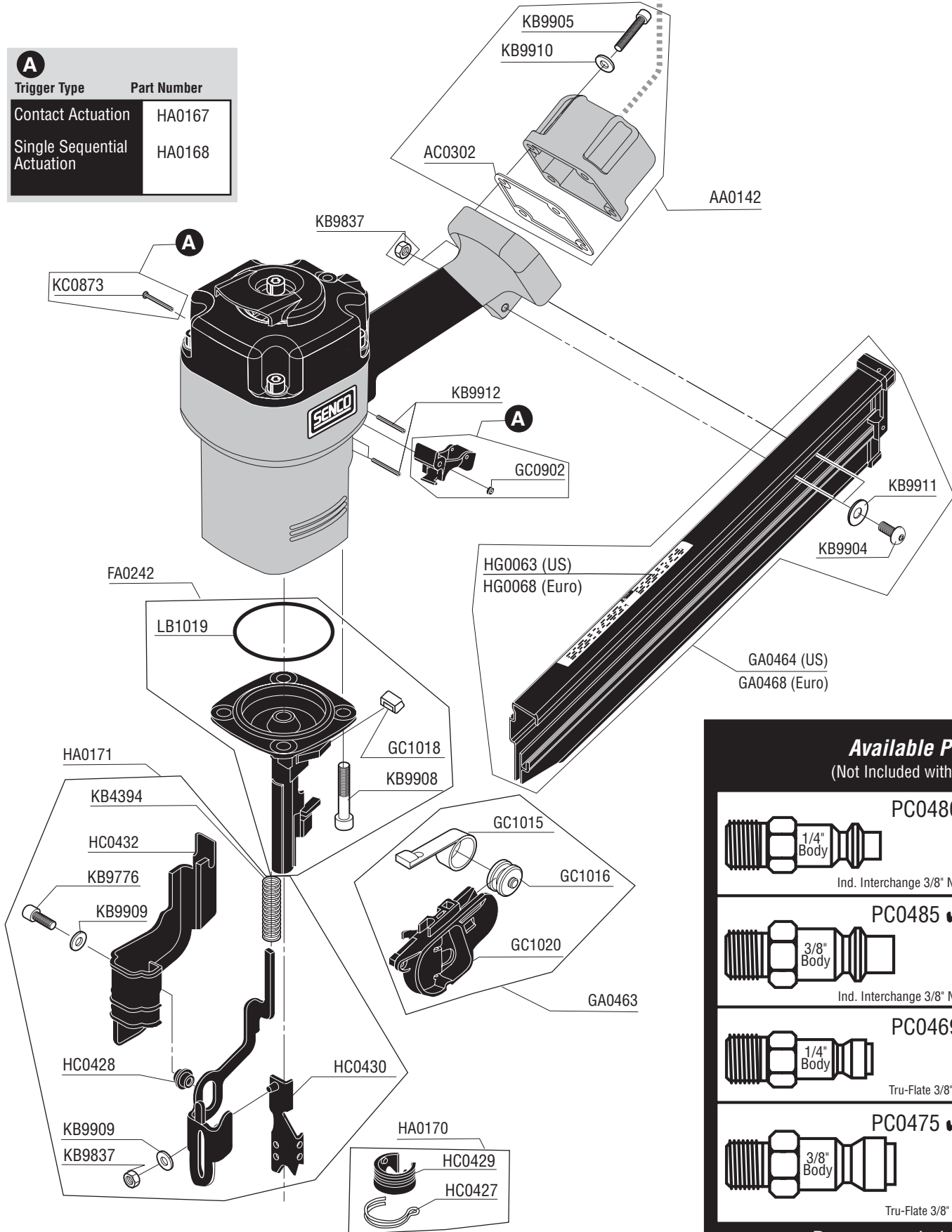
A	
Trigger Type	Part Number
Contact Actuation	HA0167
Single Sequential Actuation	HA0168

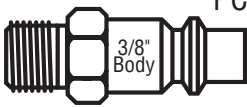

Available Plugs (Not Included with Tool)

	PC0480
	1/4" Body Ind. Interchange 3/8" NPT
	PC0485 ✓
	3/8" Body Ind. Interchange 3/8" NPT
	PC0469
	1/4" Body Tru-Flate 3/8" NPT
	PC0475 ✓
	3/8" Body Tru-Flate 3/8" NPT

✓ **Recommended Plugs**
Plugs shown smaller than actual size

MFG02G Revised November 6, 2006 (Replaces 3/13/06) © 2002, 2006 by SENCO Products, Inc. Cincinnati, Ohio 45244 - U.S.A.

FramePro® 651 Framing Nailer

REPLACEMENT PARTS LIST • LISTA DE PARTES DE REPUESTO • ERSATZTEILE-LISTE • LISTE DE PIÈCES DE RECHANGE

PART NO.	DESCRIPTION	DESCRIPCIÓN	BESCHREIBUNG	DÉSIGNATION
AA0140	DEFLECTOR ASSEMBLY	ASAMBLE DE DESVIADOR	ABWEISER-ZUSAMMENBAU	ENSEMBLE DÉFLECTEUR
AA0142	END CAP ASSEMBLY	ASAMBLE DE TAPA TERMINAL	ABSCHLUßKAPPE-ZUSAMMENBAU	BOUCHON D'EXTRÊMITE DE RAIL
AA0143	CAP ASSEMBLY	ASAMBLE DE TAPA	KAPPE-ZUSAMMENBAU	ENSEMBLE BOUCHON
AC0302	SEAL	SELLO	DICHTUNG	JOINT
BA0159	FIRING VALVE ASSEMBLY	ASAMBLE DE VÁLVULA	VENTIL-ZUSAMMENBAU	ENSEMBLE VALVE
BA0161	CYLINDER ASSEMBLY	ASAMBLE DE CILINDRO	ZYLINDER-ZUSAMMENBAU	ENSEMBLE CYLINDRE
BB0148	STOP, PISTON	TOPE	PUFFER	ARRÊT
BC0481	WASHER	ARANDELA	SCHEIBE	RONDELLE
BC0482	SEAL	SELLO	DICHTUNG	JOINT
BC0483	RETAINER, SLEEVE	RETÉN	SICHERUNGSRING	RETENUE
BC0484	SEAL	SELLO	DICHTUNG	JOINT
BC0485	WASHER	ARANDELA	SCHEIBE	RONDELLE
BC0486	RETAINER	RETÉN	SICHERUNGSRING	RETENUE
CA0108	CORE ASSEMBLY	ASAMBLE DE VÁSTAGO	VENTILSTIFT-ZUSAMMENBAU	ENSEMBLE NOYAU
EA0164	PISTON ASSEMBLY	ASAMBLE DE PISTON	KOLBEN-ZUSAMMENBAU	ENSEMBLE PISTON-COUTEAU
FA0242	GUIDE BODY ASSEMBLY	ASAMBLE DE PLACA DE NARIZ	NAGELFÜHRUNG-ZUSAMMENBAU	ENSEMBLE FRONT
GA0463	FEEDER SHOE ASSEMBLY	ASAMBLE DE ALIMENTADOR	NAGELSCHIEBER-ZUSAMMENBAU	ENSEMBLE POUSSOIR
GA0464	MAGAZINE (US)	CARGADOR	MAGAZIN	MAGASIN
GA0468	MAGAZINE (EURO)	CARGADOR	MAGAZIN	MAGASIN
GC0902	RETAINER, PIN	RETÉN	SICHERUNGSRING	RETENUE
GC1015	SPRING, FEEDER	RESORTE	FEDER	RESSORT
GC1016	ROLLER, FEEDER SPRING	RODILLO	ROLLE	GALET
GC1018	STOP	TOPE	PUFFER	ARRÊT
GC1020	FEEDER SHOE	ALIMENTADOR	NAGELSCHIEBER	POUSSOIR
HA0167	TRIGGER ASSY, DUAL ACTION	ASAMBLE DE GATILLO	AUSLÖSER-ZUSAMMENBAU	ENSEMBLE GÂCHETTE
HA0168	TRIGGER ASSY, RESTRICTIVE	ASAMBLE DE GATILLO	AUSLÖSER-ZUSAMMENBAU	ENSEMBLE GÂCHETTE
HA0170	NO-MAR PAD ASSEMBLY	ASAMBLE DE AMORTIGUADOR	SCHUTZ-ZUSAMMENBAU	ENSEMBLE COUSSIN
HA0171	SAFETY ELEMENT ASSEMBLY	ASAMBLE DE SEGURO	SICHERHEITSVORRICHTUNG-ZUSAMMENBAU	ENSEMBLE PALPEUR DE SÉCURITÉ
HC0427	SPRING	RESORTE	FEDER	RESSORT
HC0428	BUSHING	CASQUILLO	HÜLSE	DOUILLE
HC0429	NO-MAR PAD	AMORTIGUADOR	SCHUTZ	COUSSIN
HC0430	SAFETY ELEMENT	SEGURO	SICHERHEITSVORRICHTUNG	PALPEUR DE SÉCURITÉ
HC0432	COVER, SAFETY	CUBIERTA	ABDECKUNG	COUVERCLE
HG0063	LABEL (US)	ETIQUETA	AUFKLEBER	ÉTIQUETTE
HG0068	LABEL (EURO)	ETIQUETA	AUFKLEBER	ÉTIQUETTE
KB3255	SCREW	TORNILLO	SCHRAUBE	VIS
KB4393	SPRING, FIRING VALVE	RESORTE	FEDER	RESSORT
KB4394	SPRING, SAFETY	RESORTE	FEDER	RESSORT
KB9752	WASHER	ARANDELA	SCHEIBE	RONDELLE
KB9776	SCREW	TORNILLO	SCHRAUBE	VIS
KB9837	NUT	TUERCA	MUTTER	ÉCROU
KB9904	SCREW	TORNILLO	SCHRAUBE	VIS
KB9905	SCREW	TORNILLO	SCHRAUBE	VIS
KB9908	SCREW	TORNILLO	SCHRAUBE	VIS
KB9909	WASHER	ARANDELA	SCHEIBE	RONDELLE
KB9910	WASHER	ARANDELA	SCHEIBE	RONDELLE
KB9911	WASHER	ARANDELA	SCHEIBE	RONDELLE
KB9912	PIN	PASADOR	STIFT	GOUPILLE
KC0873	PIN, TRIGGER PIVOT	PASADOR	STIFT	GOUPILLE
LB0018	SEAL	SELLO	DICHTUNG	JOINT
LB0057	SEAL	SELLO	DICHTUNG	JOINT
LB1010	SEAL	SELLO	DICHTUNG	JOINT
LB1011	SEAL	SELLO	DICHTUNG	JOINT
LB1014	SEAL	SELLO	DICHTUNG	JOINT
LB1015	SEAL	SELLO	DICHTUNG	JOINT
LB1016	SEAL	SELLO	DICHTUNG	JOINT
LB1017	SEAL	SELLO	DICHTUNG	JOINT
LB1018	SEAL	SELLO	DICHTUNG	JOINT
LB1019	SEAL	SELLO	DICHTUNG	JOINT
LB1020	SEAL	SELLO	DICHTUNG	JOINT
LB1021	SEAL	SELLO	DICHTUNG	JOINT
MC5113	GRIP	AGARRADERO	GRIF	GAINE EN CUIR
YK0360	SEAL KIT	ASAMBLE DE SELLO	DICHTUNG-ZUSAMMENBAU	ENSEMBLE JOINT