

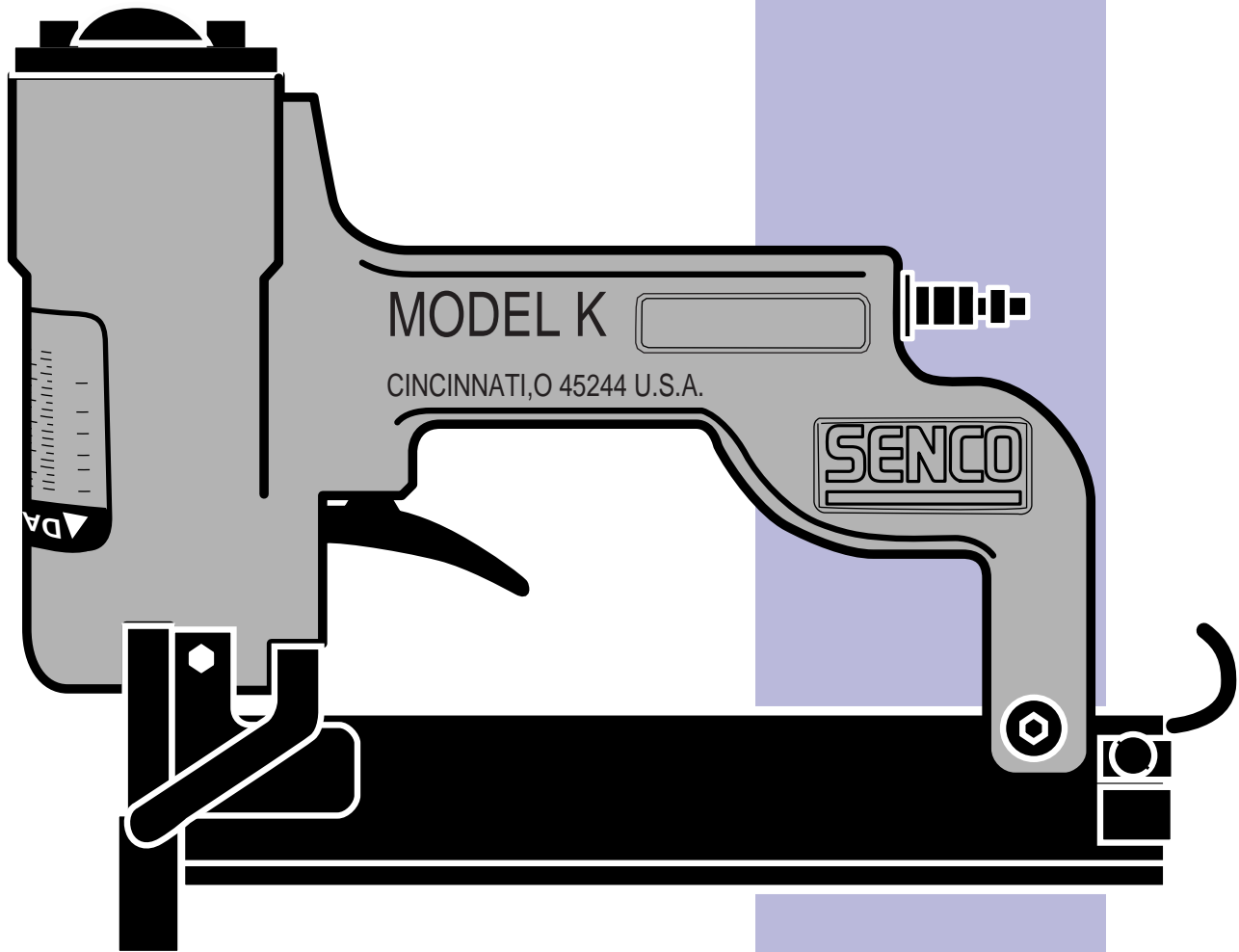

Parts Reference Guide

Made in the U.S.A. 



* Schematic Drawings inside

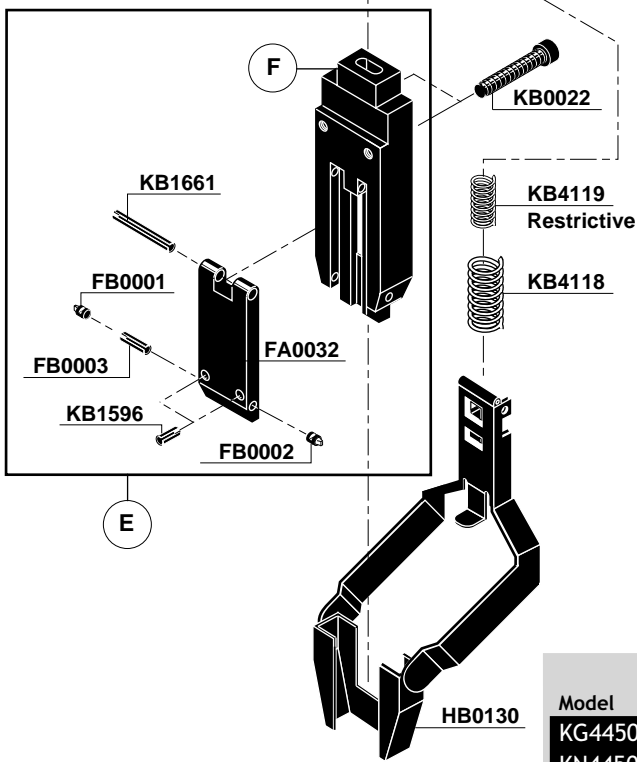
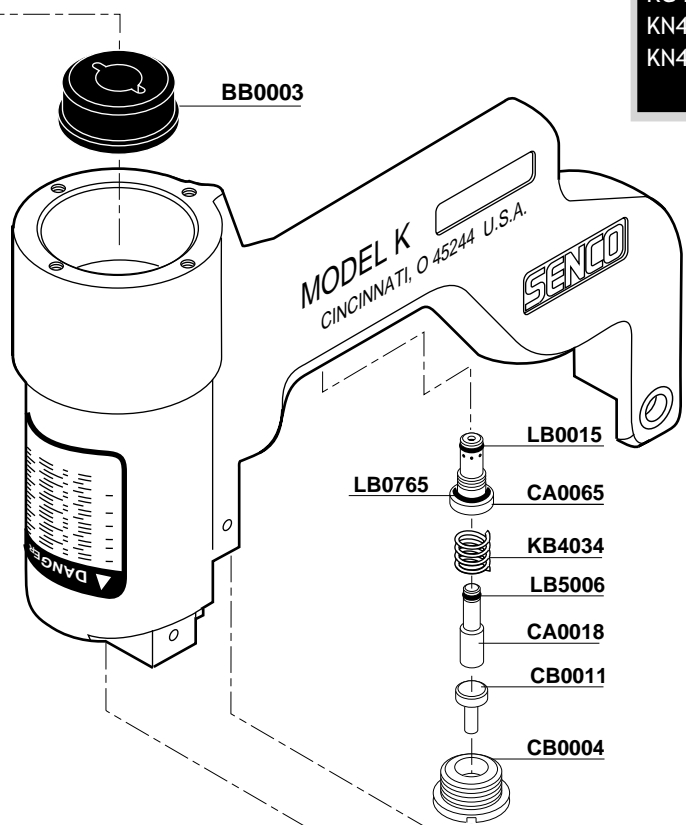
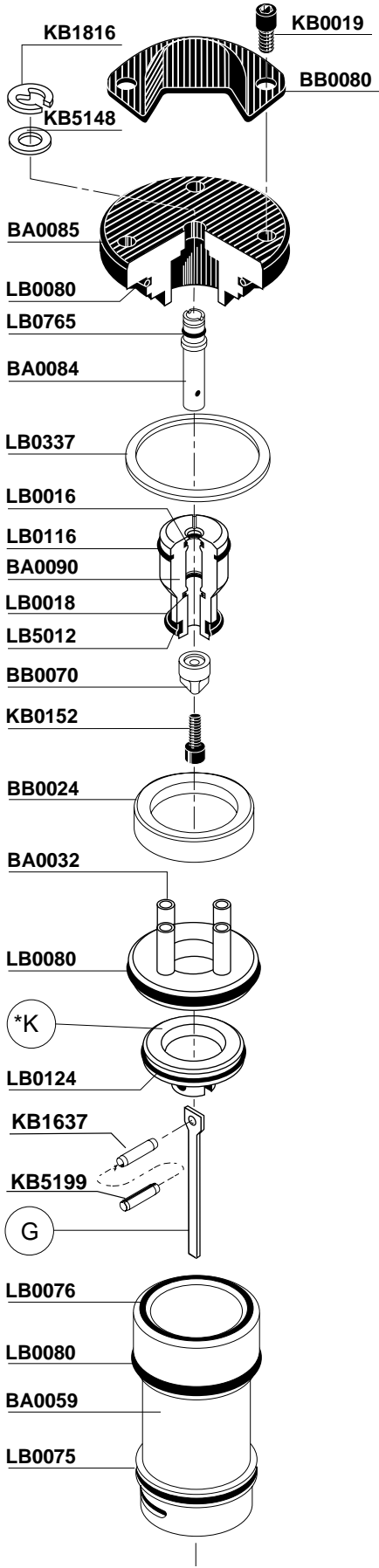

Model	G	K*
KG4450-1	EB0209	EC0037
KN4450-1 1/4	EB0031	EC0037
KN4450-1 1/2	EB0031	EC0037

*Does not include O-rings
 *No incluye sellos de gomas
 *Ohne Dichtringe
 *Joints exclus

Available Triggers

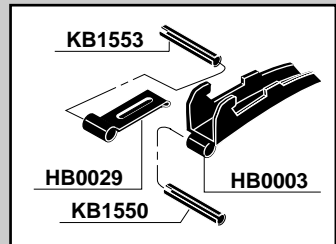

Bottom-Trip

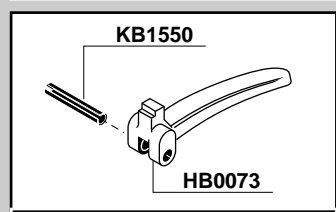

Restrictive

Model	E	F
KG4450-1	FA0024	FA0028
KN4450-1 1/4	FA0027	FA0031
KN4450-1 1/2	FA0086	FA0087

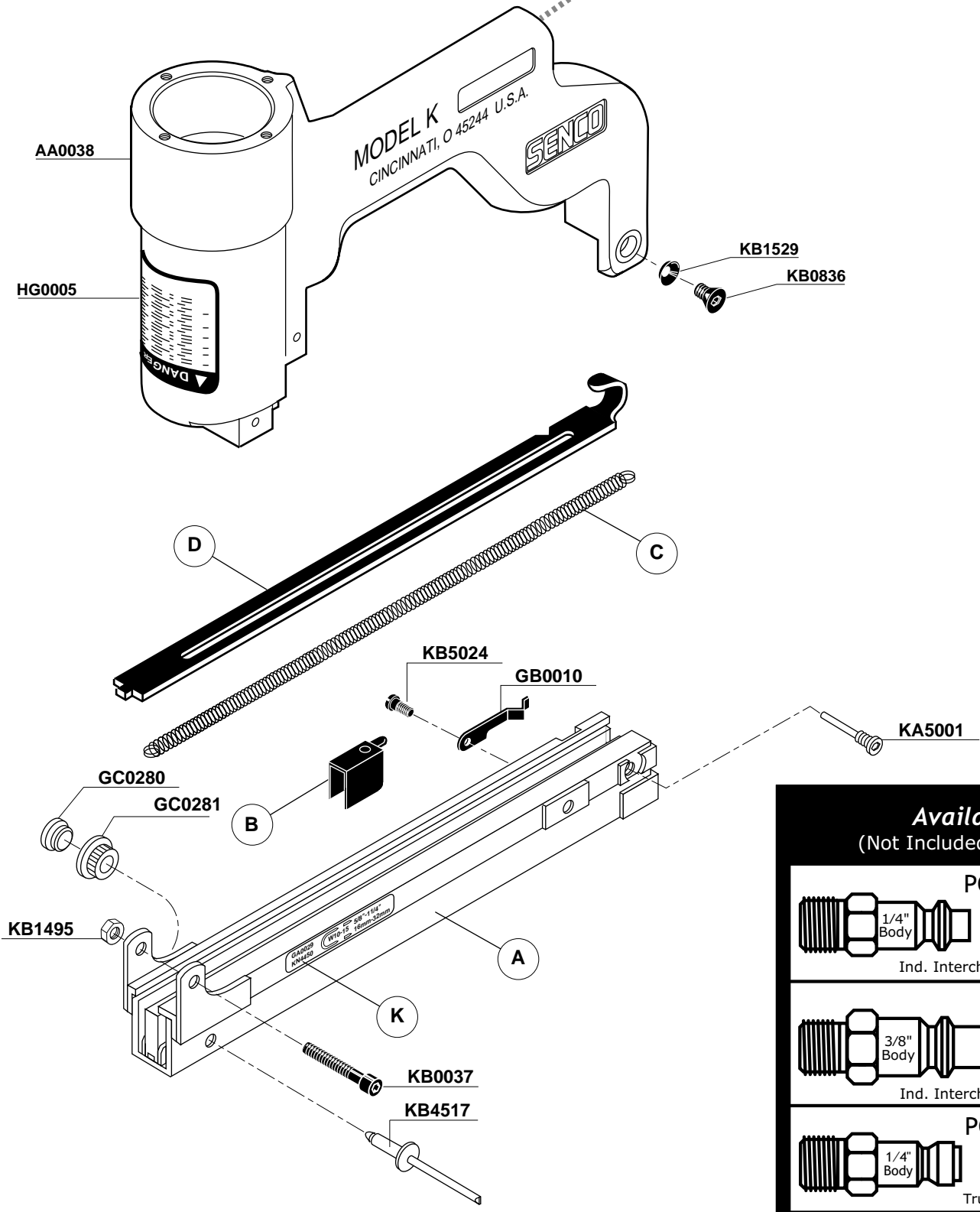

Available Plugs
(Not Included with Tool)

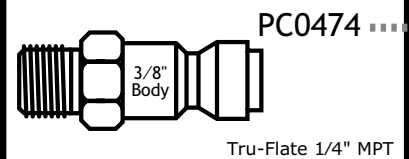
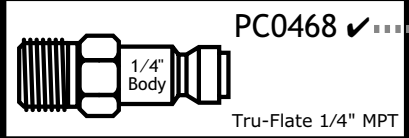
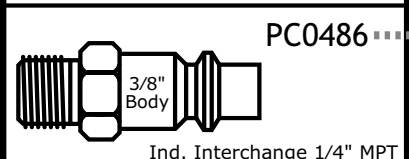
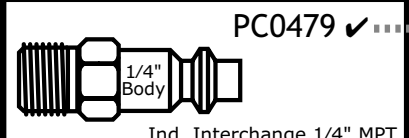

✓ **Recommended Plugs**
Plugs shown smaller than actual size

Model	A	B	C	D	K
KG4450-1	GA0027	GA0031	KB5022	GB0012	GG0075
KN4450-1 1/4	GA0029	GA0033	KB5023	GB0013	GG0076
KN4450-1 1/2	GA0108	GA0033	KB5023	GB0013	GG0107



REPLACEMENT PARTS LIST • LISTA DE PARTES DE REPUESTO • ERSATZTEILE-LISTE • LISTE DE PIÈCES DE RECHANGE

PART NO.	DESCRIPTION	DESCRIPCIÓN	BESCHREIBUNG	DÉSIGNATION
AA0038	MAIN BODY ASSY.	CARCASA	GEHÄUSE	CORPS
BA0032	SEAT	ASIENTO	SITZ	SIÈGE
BA0059	CYLINDER ASSY.	ASAMBLE DE CILINDRO	ZYLINDER-ZUSAMMENBAU	CYLINDRE D'ASSEMBLÉE
BA0084	VALVE ASSEMBLY	ASAMBLE DE VALVULA	VENTIL-ZUSAMMENBAU	VALVE D'ASSEMBLÉE
BA0085	CAP	TAPA	KAPPE	BOUCHON
BA0090	VALVE ASSEMBLY	ASAMBLE DE VALVULA	VENTIL-ZUSAMMENBAU	VALVE D'ASSEMBLÉE
BB0003	STOP	TOPE	PUFFER	ARRÊT
BB0024	SEAT	ASIENTO	SITZ	SIÈGE
BB0070	VALVE	VALVULA	VENTIL	VALVE
BB0080	DEFLECTOR	DESVIADOR	ABWEISER	DÉFLECTEUR
CA0018	VALVE ASSEMBLY	ASAMBLE DE VALVULA	VENTIL-ZUSAMMENBAU	VALVE D'ASSEMBLÉE
CA0065	VALVE ASSEMBLY	ASAMBLE DE VALVULA	VENTIL-ZUSAMMENBAU	VALVE D'ASSEMBLÉE
CB0004	CAP	TAPA	KAPPE	BOUCHON
CB0011	VALVE	VALVULA	VENTIL	VALVE
EA0008	PISTON ASSEMBLY#5	ASAMBLE DE PISTON	KOLBEN-ZUSAMMENBAU	PISTON D'ASSEMBLÉE
EA0009	PISTON ASSEMBLY#6	ASAMBLE DE PISTON	KOLBEN-ZUSAMMENBAU	PISTON D'ASSEMBLÉE
EB0028	DRIVER (KG4450 1/16 CSK)	PERCUSOR	TREIBER	COUTEAU
EB0030	DRIVER (KN4450 1/16 CSK)	PERCUSOR	TREIBER	COUTEAU
EB0031	DRIVER (KN4450 1/8 CSK)	PERCUSOR	TREIBER	COUTEAU
EB0209	DRIVER (KG4450 1/8 CSK)	PERCUSOR	TREIBER	COUTEAU
EB0210	DRIVER (KN4450 3/16 CSK)	PERCUSOR	TREIBER	COUTEAU
FA0024	GUIDE BODY ASSY. (KG4450-1")	ASAMBLE DE PLACA DE NARIZ	KLAMMERFÜHRUNG-ZUSAMMENBAU	FRONT D'ASSEMBLÉE
FA0027	GUIDE BODY (KN4450-11/4")	ASAMBLE DE PLACA DE NARIZ	KLAMMERFÜHRUNG-ZUSAMMENBAU	FRONT D'ASSEMBLÉE
FA0028	PLATE (KG4450-1")	PLACA	PLATTE	PLAQUE
FA0031	PLATE (KN4450-11/4")	PLACA	PLATTE	PLAQUE
FA0032	PLATE	PLACA	PLATTE	PLAQUE
FA0052	PLATE (KG4450-11/2")	PLACA	PLATTE	PLAQUE
FA0054	GUIDE BODY ASSY. (KG4450-11/2")	ASAMBLE DE PLACA DE NARIZ	KLAMMERFÜHRUNG-ZUSAMMENBAU	FRONT D'ASSEMBLÉE
FA0086	GUIDE BODY (KN4450-11/2")	ASAMBLE DE PLACA DE NARIZ	KLAMMERFÜHRUNG-ZUSAMMENBAU	FRONT D'ASSEMBLÉE
FA0087	PLATE (KN4450-11/2")	PLACA	PLATTE	PLAQUE
FB0001	PIN	PASADOR	STIFT	GOUPILLE
FB0002	PIN	PASADOR	STIFT	GOUPILLE
FB0003	BUSHING	CASQUILLO	HÜLSE	DOUILLE
GA0027	RAIL ASSY. (KG4450-1")	ASAMBLE DE CARRIL	SCHIENE-ZUSAMMENBAU	RAIL D'ASSEMBLÉE
GA0029	RAIL ASSY. (KN4450-11/4")	ASAMBLE DE CARRIL	SCHIENE-ZUSAMMENBAU	RAIL D'ASSEMBLÉE
GA0031	FEEDER SHOE (KG4450)	ALIMENTADOR	KLAMMERSCHIEBER	POUSSOIR
GA0033	FEEDER SHOE (KN-11/4, 11/2)	ALIMENTADOR	KLAMMERSCHIEBER	POUSSOIR
GA0056	FEEDER SHOE (KG4450-11/2)	ALIMENTADOR	KLAMMERSCHIEBER	POUSSOIR
GA0108	RAIL ASSY. (KN4450-11/2")	ASAMBLE DE CARRIL	SCHIENE-ZUSAMMENBAU	RAIL D'ASSEMBLÉE
GB0010	RETAINER	JUNTA TÓRICA	SICHERUNGSRING	RETENUE
GB0012	GUIDE (KG4450)	GUÍA	FÜHRUNG	GUIDE
GB0013	GUIDE (KN)	GUÍA	FÜHRUNG	GUIDE
GC0280	RETAINER	JUNTA TÓRICA	SICHERUNGSRING	RETENUE
GC0281	ROLLER	RODILLO	ROLLE	GALET
GG0075	LABEL	ETIQUETA	AUFKLEBER	ÉTIQUETTE
GG076	LABEL	ETIQUETA	AUFKLEBER	ÉTIQUETTE
GG0107	LABEL	ETIQUETA	AUFKLEBER	ÉTIQUETTE
HB0003	TRIGGER	GATILLO	AUSLÖSER	GACHETTE
HB0029	TRIGGER	GATILLO	AUSLÖSER	GACHETTE
HB0073	TRIGGER	GATILLO	AUSLÖSER	GACHETTE
HB0130	SAFETY ELEMENT	SEGURO	SICHERHEITSVORRICHTUNG	PALPEUR DE SÉCURITÉ
HG0005	LABEL	ETIQUETA	AUFKLEBER	ÉTIQUETTE
	(SAFETY PRECAUTIONS)	(NORMAS DE SEGURIDAD)	(SICHERHEITSHINWEISE)	(PRÉCAUTIONS DE SÉCURITÉ)
KA5001	RETAINER	JUNTA TÓRICA	SICHERUNGSRING	RETENUE
KB0019	SCREW	TORNILLO	SCHRAUBE	VIS
KB0022	SCREW	TORNILLO	SCHRAUBE	VIS
KB0037	SCREW	TORNILLO	SCHRAUBE	VIS
KB0152	SCREW	TORNILLO	SCHRAUBE	VIS
KB0836	SCREW	TORNILLO	SCHRAUBE	VIS
KB1495	NUT	TUERCA	MÜTTER	ÉCROU
KB1529	WASHER	ARANDELA	SCHEIBE	RONDELLE
KB1550	PIN	PASADOR	STIFT	GOUPILLE
KB1553	PIN	PASADOR	STIFT	GOUPILLE
KB1596	PIN	PASADOR	STIFT	GOUPILLE
KB1637	PIN	PASADOR	STIFT	GOUPILLE
KB1661	PIN	PASADOR	STIFT	GOUPILLE
KB1816	RETAINER	JUNTA TÓRICA	SICHERUNGSRING	RETENUE
KB4034	SPRING	RESORTE	FEDER	RESSORT
KB4118	SPRING	RESORTE	FEDER	RESSORT
KB4119	SPRING	RESORTE	FEDER	RESSORT
KB4517	PIN	PASADOR	STIFT	GOUPILLE
KB5022	SPRING	RESORTE	FEDER	RESSORT
KB5023	SPRING	RESORTE	FEDER	RESSORT
KB5148	WASHER	ARANDELA	SCHEIBE	RONDELLE
KB5199	PIN	PASADOR	STIFT	GOUPILLE
LB0015	SEAL	SELLO	DICHTUNG	JOINT
LB0016	SEAL	SELLO	DICHTUNG	JOINT
LB0018	SEAL	SELLO	DICHTUNG	JOINT
LB0075	SEAL	SELLO	DICHTUNG	JOINT
LB0080	SEAL	SELLO	DICHTUNG	JOINT
LB0116	SEAL	SELLO	DICHTUNG	JOINT
LB0124	SEAL	SELLO	DICHTUNG	JOINT
LB0337	SEAL	SELLO	DICHTUNG	JOINT
LB0765	SEAL	SELLO	DICHTUNG	JOINT
LB5006	SEAL	SELLO	DICHTUNG	JOINT
LB5012	SEAL	SELLO	DICHTUNG	JOINT

Questions? Comments? call SENCO's toll-free Action-line: 1-800-543-4596 or e-mail: toolprof@senco.com