

FUSION[™]
TECHNOLOGY

F-35FRHXP
**CORDLESS
FRAMING NAILER**

Operating Instructions

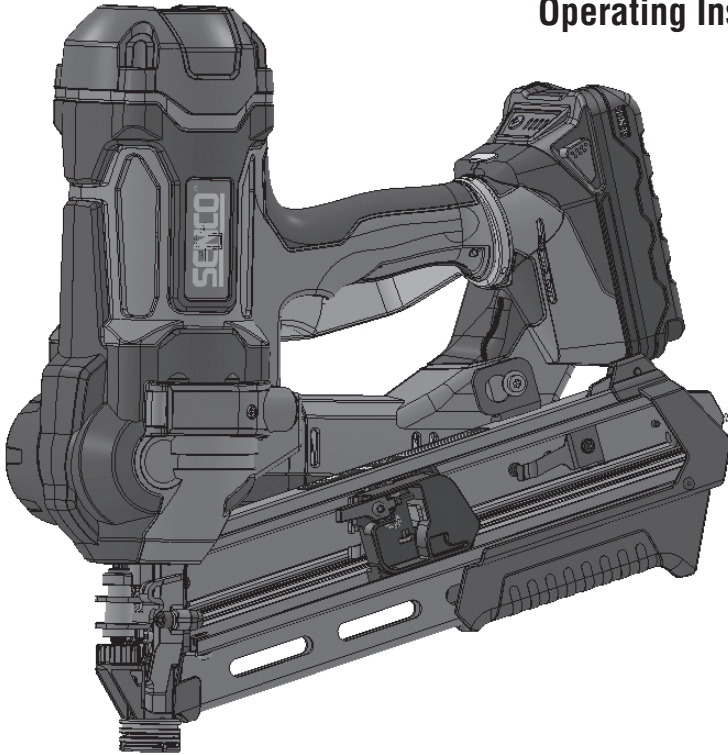

SENCO[®]



IMPORTANT:
Read before use.



KYOCERA-SENCO Industrial Tools, Inc.
8450 Broadwell Road
Cincinnati, OH 45244
1-800-543-4596
www.senco.com

NFD810HENG • Issued December 31, 2020



© 2020 by KYOCERA-SENCO Industrial Tools, Inc.

Table of Contents









Symbols	3
General Power Tool Safety Warnings	4
Work Area Safety.....	4
Electrical Safety.....	4
Personal Safety.....	4
Power Tool Use and Care.....	5
Battery Tool Use and Care.....	5
Service.....	6
Nailer Safety Warnings	6
Additional Tool Safety Warnings	7
Safety Warnings for Charger and Battery	9
Functional Description	11
Tool Operation	12
Mode Selection.....	12
Warning Light.....	14
Time-Out / Lockout.....	15
Depth of Drive Adjustment.....	15
Belt Hook.....	15
Fastener Jam.....	16
Battery Charging	17
Battery Disposal.....	18
Maintenance	18
Accessories	18
Fastener Specifications	19
Technical Specifications	19
Troubleshooting	20

SYMBOLS

The following signal words and meanings are intended to explain the levels of risk associated with this product.

SYMBOL	SIGNAL	MEANING
	DANGER:	Indicates a hazardous situation, which, if not avoided, will result in death or serious injury.
	WARNING:	Indicates a hazardous situation, which, if not avoided, could result in death or serious injury.
	CAUTION:	Indicates a hazardous situation, which, if not avoided, may result in minor or moderate injury.
	NOTICE:	(Without Safety Alert Symbol) indicates information considered important, but not related to a potential injury (e.g. messages relating to property damage).

Some of the following symbols may be used on this product. Please study them and learn their meaning. Proper interpretation of these symbols will allow you to operate the product in a better, safer manner.

SYMBOL	NAME	DESIGNATION/EXPLANATION
	Safety Alert	Indicates a potential personal injury hazard.
	Read Operator's Manual	To reduce the risk of injury, user must read and understand operator's manual before using this product.
	Eye Protection	Always wear eye protection with side shields marked to comply with ANSI Z87.1.
		Do not rest your finger on the trigger when picking up the tool, moving between operating areas and positions or walking, as resting finger on trigger can lead to inadvertent operation. For tools with selective actuation, always check the tool before use to ascertain the correct mode is selected. This tool has either selective actuation for contact actuation or continuous contact actuation by actuation mode selectors or is a contact actuation or continuous actuation contact tool and has been marked with the symbol above. If using this tool in selective actuation mode, always ensure it is in the correct actuation setting. Be careful when changing from one driving location to another.
	Do Not Oil	Routine lubrication is not necessary.
	Wet Conditions Alert	Do not expose to rain or use in damp locations.
	Recycle	This product uses Lithium-ion batteries. Local, state, or federal laws may prohibit disposal of batteries in ordinary trash. Consult your local waste authority for information regarding available recycling and or disposal options.
V	Volts	Voltage
	Direct Current	Type or characteristic of current

General Power Tool Safety Warnings

⚠️ WARNING Read all safety warnings, instructions, illustrations and specifications provided with this power tool. Failure to follow all instructions listed below may result in electric shock, fire and/or serious injury.

Save all warnings and instructions for future reference.

The term “power tool” in the warnings refers to your mains-operated (corded) power tool or battery-operated (cordless) power tool.

WORK AREA SAFETY

1. **Keep work area clean and well lit.** Cluttered or dark areas invite accidents.
2. **Do not operate power tools in explosive atmospheres, such as in the presence of flammable liquids, gases or dust.** Power tools create sparks which may ignite the dust or fumes.
3. **Keep children and bystanders away while operating a power tool.** Distractions can cause you to lose control.

ELECTRICAL SAFETY

4. **Power tool plugs must match the outlet. Never modify the plug in any way. Do not use any adapter plugs with earthed (grounded) power tools.** Unmodified plugs and matching outlets will reduce risk of electric shock.
5. **Avoid body contact with earthed or grounded surfaces, such as pipes, radiators, ranges and refrigerators.** There is an increased risk of electric shock if your body is earthed or grounded.
6. **Do not expose power tools to rain or wet conditions.** Water entering a power tool will increase the risk of electric shock.
7. **Do not abuse the cord. Never use the cord for carrying, pulling or unplugging the power tool. Keep cord away from heat, oil, sharp edges or moving parts.** Damaged or entangled cords increase the risk of electric shock.
8. **When operating a power tool outdoors, use an extension cord suitable for outdoor use.** Use of a cord suitable for outdoor use reduces the risk of electric shock.
9. **If operating a power tool in a damp location is unavoidable, use a residual current device (RCD) protected supply.** Use of an RCD reduces the risk of electric shock.

PERSONAL SAFETY

10. **Stay alert, watch what you are doing and use common sense when operating a power tool. Do not use a power tool while you are tired or under the influence of drugs, alcohol or medication.** A moment of inattention while operating power tools may result in serious personal injury.
11. **Use personal protective equipment. Always wear eye protection.** Protective equipment such as dust mask, non-skid safety shoes, hard hat, or hearing protection used for appropriate conditions will reduce personal injuries.
12. **Prevent unintentional starting. Ensure the switch is in the off-position before connecting to power source and/or battery pack, picking up or carrying the tool.** Carrying power tools with your finger on the switch or energizing power tools that have the switch on invites accidents.
13. **Remove any adjusting key or wrench before turning the power tool on.** A wrench or a key left attached to a rotating part of the power tool may result in personal injury.
14. **Do not overreach. Keep proper footing and balance at all times.** This enables better control of the power tool in unexpected situations.

GENERAL POWER TOOL SAFETY WARNINGS

- 15. Dress properly. Do not wear loose clothing or jewelry. Keep your hair, clothing and gloves away from moving parts.** Loose clothes, jewelry or long hair can be caught in moving parts.
- 16. If devices are provided for the connection of dust extraction and collection facilities, ensure these are connected and properly used.** Use of dust collection can reduce dust-related hazards.
- 17. Do not let familiarity gained from frequent use of tools allow you to become complacent and ignore tool safety principles.** A careless action can cause severe injury within a fraction of a second.

POWER TOOL USE AND CARE

- 18. Do not force the power tool. Use the correct power tool for your application.** The correct power tool will do the job better and safer at the rate for which it was designed.
- 19. Do not use the power tool if the switch does not turn it on and off.** Any power tool that cannot be controlled with the switch is dangerous and must be repaired.
- 20. Disconnect the plug from the power source and/or remove the battery pack, if detachable, from the power tool before making any adjustments, changing accessories, or storing power tools.** Such preventive safety measures reduce the risk of starting the power tool accidentally.
- 21. Store idle power tools out of the reach of children and do not allow persons unfamiliar with the power tool or these instructions to operate the power tool.** Power tools are dangerous in the hands of untrained users.
- 22. Maintain power tools and accessories. Check for misalignment or binding of moving parts, breakage of parts and any other condition that may affect the power tool's operation. If damaged, have the power tool repaired before use.** Many accidents are caused by poorly maintained power tools.
- 23. Keep cutting tools sharp and clean.** Properly maintained cutting tools with sharp cutting edges are less likely to bind and are easier to control.
- 24. Use the power tool, accessories and tool bits etc. in accordance with these instructions, taking into account the working conditions and the work to be performed.** Use of the power tool for operations different from those intended could result in a hazardous situation.
- 25. Keep handles and grasping surfaces dry, clean and free from oil and grease.** Slippery handles and grasping surfaces do not allow for safe handling and control of the tool in unexpected situations.

BATTERY TOOL USE AND CARE

- 26. Recharge only with the charger specified by the manufacturer.** A charger that is suitable for one type of battery pack may create a risk of fire when used with another battery pack.
- 27. Use power tools only with specifically designated battery packs.** Use of any other battery packs may create a risk of injury and fire.
- 28. When battery pack is not in use, keep it away from other metal objects, like paper clips, coins, keys, nails, screws or other small metal objects, that can make a connection from one terminal to another.** Shorting the battery terminals together may cause burns or a fire.
- 29. Under abusive conditions, liquid may be ejected from the battery; avoid contact. If contact accidentally occurs, flush with water. If liquid contacts eyes, additionally seek medical help.**
Liquid ejected from the battery may cause irritation or burns.
- 30. Do not use a battery pack or tool that is damaged or modified.** Damaged or modified batteries may exhibit unpredictable behaviour resulting in fire, explosion or risk of injury.
- 31. Do not expose a battery pack or tool to fire or excessive temperature.** Exposure to fire or temperature above 130 °C may cause explosion.

32. **Follow all charging instructions and do not charge the battery pack or tool outside the temperature range specified in the instructions.** Charging improperly or at temperatures outside the specified range may damage the battery and increase the risk of fire.

SERVICE

33. **Have your power tool serviced by a qualified repair person using only identical replacement parts.** This will ensure that the safety of the power tool is maintained.
34. **Never service damaged battery packs.** Service of battery packs should only be performed by the manufacturer or authorized service providers.

Nailer Safety Warnings

1. **Always assume the tool contains fasteners.** Careless handling of the nailer can result in unexpected firing of fasteners and personal injury.
2. **Do not point the tool towards yourself or anyone nearby.** Unexpected triggering will discharge the fastener causing an injury.
3. **Do not actuate the tool unless the tool is placed firmly against the workpiece.** If the tool is not in contact with the workpiece, the fastener may be deflected away from your target.
4. **Disconnect the tool from the power source when the fastener jams in the tool.** While removing a jammed fastener, the nailer may be accidentally activated if it is plugged in.
5. **Use caution while removing a jammed fastener.** The mechanism may be under compression and the fastener may be forcefully discharged while attempting to free a jammed condition.
6. **Do not use this nailer for fastening electrical cables.** It is not designed for electric cable installation and may damage the insulation of electric cables thereby causing electric shock or fire hazards.
7. **Hold the power tool by insulated gripping surfaces, when performing an operation where the fastener may contact hidden wiring.** Fasteners contacting a “live” wire may make exposed metal parts of the power tool “live” and could give the operator an electric shock.
8. **Do not use the power tool in locations where the ambient temperature may reach 4°C (39.2°F) or exceed 40°C (105°F).**
9. **A battery short can cause a large current flow, overheating, possible burns and even a breakdown.**
 - Do not touch the terminals with any conductive material.
 - Avoid storing battery cartridge in a container with other metal objects such as nails, coins, etc.
 - Do not expose battery cartridge to water or rain.
10. Consecutive charging may cause overheating. If you need to recharge batteries consecutively, wait about 15 minutes for the charger to cool.

Additional Safety Warnings



To prevent eye injuries, always wear OSHA required “Z87” safety glasses with permanently attached rigid, hard plastic side shields. These safety glasses must have “Z87” printed or stamped on them. Be sure everyone in your work area is wearing the same type of safety glasses.



DANGER:

The Fusion tool is charged with compressed air in a sealed chamber. Prior to any service or repair, release the charge of pressurized air.

The pressurized air must be released prior to service. Major components such as the piston/driver assembly, gearbox, piston stop and guide body are all part of the drive assembly.

Deliberate tampering with the drive assembly may result in the release of the driver.

Any repair or upgrade requiring access to the pressure chamber may be handled by an authorized Senco dealer or service center.

Disconnect tool from battery when:

- Outside of the operator’s supervision or control.
- Performing maintenance or repair
- Clearing a jam
- Moving the tool to a new location

With battery disconnected, make daily inspection to assure free movement of workpiece contact element and trigger. Do not use tool if workpiece contact element or trigger sticks or binds.

Always remove finger from trigger when not driving fasteners. Never carry the tool with finger on or under trigger. Tool will eject a fastener if the workpiece contact element is bumped and the trigger is pulled.

Drive fasteners into work surface only; never into materials too hard to penetrate.

Do not drive fasteners on top of other fasteners or with the tool at too steep of an angle; the fasteners can ricochet and hurt someone.

When using tool, care should be taken due to possibility of tool recoil after a fastener is driven. If workpiece contact element is unintentionally allowed to re-contact work surface following a recoil, an unwanted fastener may be driven. Therefore, allow tool to recoil completely off work surface after a fastener is driven to avoid this condition. Do not push workpiece contact element on work surface until a second fastener is desired.

Please review triggering options.

Do not drive fasteners close to the edge of the work surface. The workpiece is likely to split and the fastener could fly or ricochet and hit someone.

Never use any part of the tool (i.e., the cap or mainbody) as a hammer. The tool may activate or become damaged and result in an unsafe condition.

SAFETY WARNINGS



Keep hands and other body parts away from the area shown in the circle to avoid possible injury during operation.

Do not use tool without Danger Label on tool. If label is missing, damaged or unreadable, contact your Senco representative to obtain a new label at no cost.



Tool Use



Read and understand tool labels and manual. Failure to follow warnings could result in DEATH or SERIOUS INJURY.



Operators and others in work area **MUST** wear safety glasses with side shields.



Keep fingers **AWAY** from trigger when not driving fasteners, to avoid accidental firing.

Choice of triggering method is important. See page 13 for triggering options.

Never point tool at yourself or others in work area.

Always point the tool away when connecting battery.

Do not alter or remove trigger or safety.

Tools shall not be modified without written approval of the manufacturer.

Use clamps or other practical ways to secure and support the workpiece to a stable platform. Holding the work by hand or against your body is unstable and may lead to loss of control.

Battery Use



ADDITIONAL SAFETY RULES FOR CHARGER & BATTERY CARTRIDGE

SAVE THESE INSTRUCTIONS

This manual contains important safety and operating instructions for Senco battery charger VB0189 (US).

Before using Senco battery charger VB0189 (US), read all instructions and cautionary markings on (1) battery charger, and (2) battery.

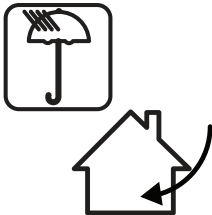

Do not expose charger to water, rain, or snow.

Use indoors.

Use of an attachment not recommended or sold by the battery charger manufacturer may result in a risk of fire, electric shock, or injury to persons.

To reduce risk of damage to electric plug and cord, pull by plug rather than cord when disconnecting charger.

Make sure cord is located so that it will not be stepped on, tripped over, or otherwise subjected to damage or stress.

RECOMMENDED MINIMUM AWG SIZE FOR EXTENSION CORDS FOR BATTERY CHARGERS

An extension cord should not be used unless absolutely necessary. Use of improper extension cord could result in a risk of fire and electric shock.

If extension cord must be used, make sure:

- That pins on plug of extension cord are the same number, size, and shape as those of plug on charger;
- That extension cord is properly wired and in good electrical condition; and
- That wire size is at least as large as the one specified in the table.

Length of Cord (Feet)			
25	50	100	150
16	16	16	14
AWG Size of Cord			

Largo del cable (m [pies])			
7,5	15	30	45
16	16	16	14
Calibre AWG del cable			

Longueur du cordon (en m)			
7,5	15	30	45
16	16	16	14
Taille AWG du cordon			

Do not operate charger with damaged cord or plug. If damaged, have replaced immediately by a qualified serviceman.

Do not operate charger if it has received a sharp blow, been dropped, or otherwise damaged in any way; take it to a Senco Authorized Service Center.

BATTERY AND CHARGER SAFETY WARNINGS

Do not disassemble charger or battery cartridge; take it to a SENCO Authorized Service Center when service or repair is required. Incorrect reassembly may result in a risk of electric shock or fire.

To reduce risk of electric shock, unplug charger from outlet before attempting any maintenance or cleaning.



Do not charge battery cartridge when temperature is BELOW 0°C (32°F) or ABOVE 40°C (104°F).

Do not attempt to use a step-up transformer, an engine generator or DC power receptacle.

Do not recharge non-rechargeable batteries.

Do not allow anything to cover or clog the charger vents.

Do not store the tool and battery cartridge in locations where the temperature may reach or exceed 45°C (113°F).

Do not incinerate the battery cartridge even if it is severely damaged or is completely worn out. The battery cartridge can explode in a fire.

Never attempt to connect two (2) chargers together.

This appliance is not intended for use by young children or infirm persons unless they have been adequately supervised by a responsible person to ensure that they do not play with the appliance.

This appliance is not intended for use by persons (including children) with reduced physical, sensory or mental capabilities, or lack of experience and knowledge, unless they have been given supervision or instruction concerning use of the appliance by a person responsible for their safety. Children should be supervised to ensure that they do not play with the appliance.



WARNING

This product contains chemicals, including lead, known to the State of California to cause cancer, and birth defects or other reproductive harm.
Wash hands after handling.

For more safety information, go to www.senco.com and safety training materials and programs visit the ISANTA website at www.isanta.org
www.P65Warnings.ca.gov

Functional Operation

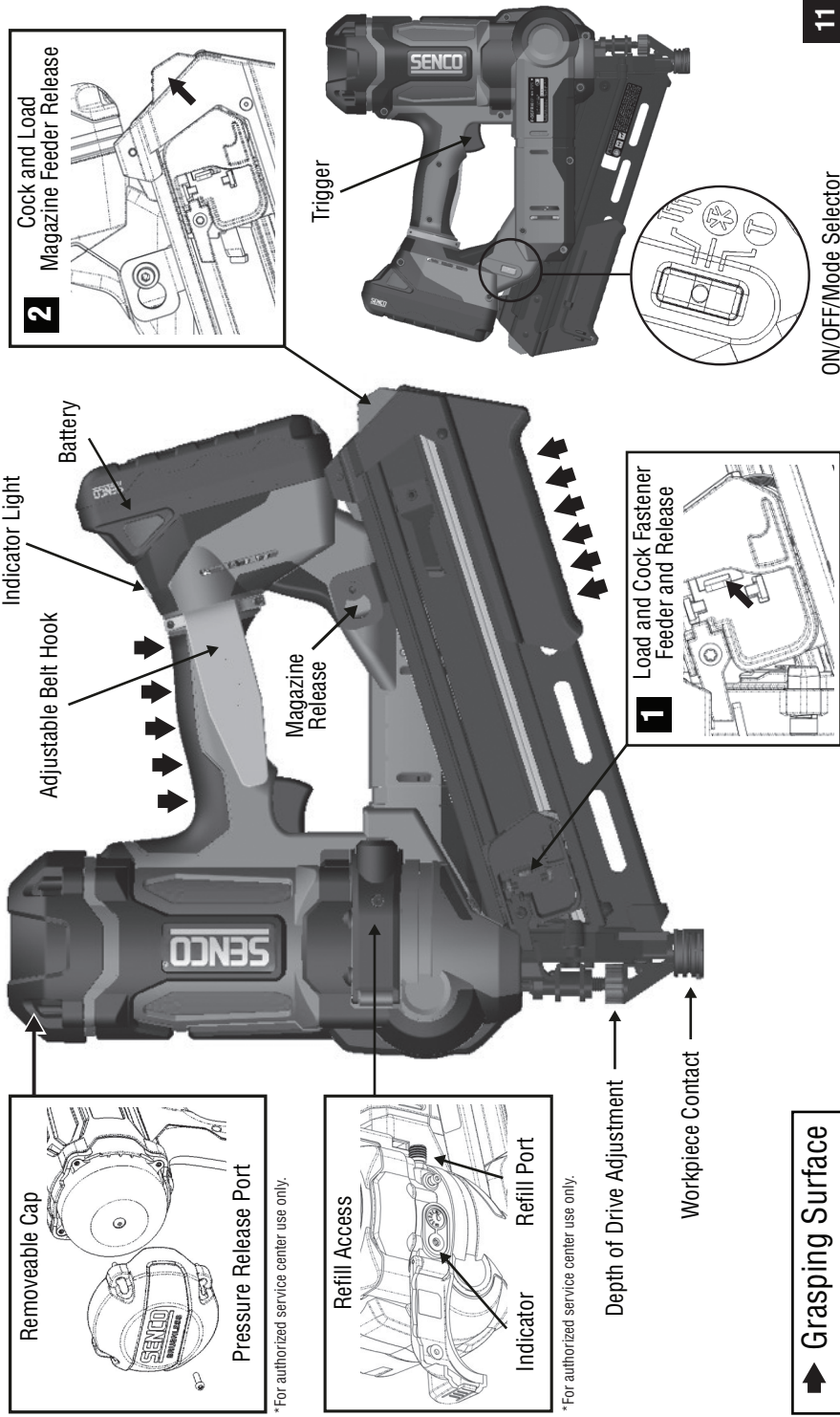

*For authorized service center use only.

*For authorized service center use only.

TOOL OPERATION

LOADING THE TOOL:

Dual-Mode Loading

Two methods to load:

1. Nails First
 - a. Insert strip of nails into the rear of the magazine.
 - b. Pull feeder shoe back beyond the end of the strip of nails and release. Reference image 1 on pg. 11.
 2. Feeder Shoe First
 - a. Pull feeder shoe all the way back until button at rear of magazine locks.
 - b. Insert strip of nails into the rear of the magazine.
 - c. Push down on red latch at rear of the magazine to release feeder shoe. Reference image 2 on pg. 11.
- Use only genuine SENCO fasteners (see Fastener Specifications).
 - Do not load with workpiece contact (safety element) or trigger depressed.

UNLOADING THE TOOL:

Push Button on feeder shoe to release feeder from strip. Pull fastener strip out past sheet metal nail detainer.

Tool Operation

Read section titled "Safety Warnings," before using tool.

For best results, charge new battery before using. (see "To Charge Battery" on page 17).

Indicator LED ON-Flashing

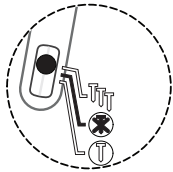

The tool should be switched off when not in use. Hold down either side of the selector switch for 1 second to turn the tool off. If left on, the tool will automatically turn off after 60 minutes.

All Fusion tools are equipped with selective-actuation triggering. This allows the user to choose between the following modes of operation:

Indicator LED ON-Solid

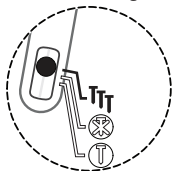

Contact Actuation

Pressing the side of the selector switch toward the **TTT** symbol (as shown) for 0.5 sec. will turn the tool on in contact-actuation mode. This is indicated by the flashing green LED of the selector switch.

Sequential

Pressing the side of the selector switch toward the **T** symbol (as shown) for 0.5 sec. will turn the tool on in sequential mode. This is indicated by the solid green LED of the selector switch.

TOOL OPERATION

In the “**contact-actuation**” mode, nails can be driven in two ways:

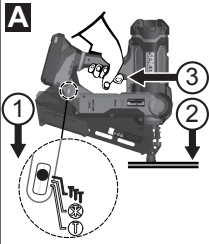

The first way:

1. Press the **TTT** side of the selector switch for 0.5 seconds. This will be indicated by the flashing green LED on the selector switch.
2. Press the workpiece contact (safety) element against the work surface.
3. Pull the trigger and the fastener is driven.

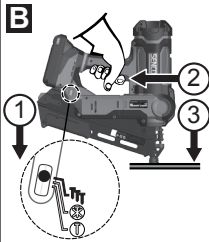

The Second way:

1. Press the **TTT** side of the selector switch for 0.5 seconds. This will be indicated by the flashing green LED on the selector switch.
2. Pull trigger.
3. Depress workpiece contact element against work surface and drive a fastener.

This mode of operation is preferred when you desire high production, rapid fastener placement.

In the “**sequential-actuation**” mode, nails can only be driven one way:

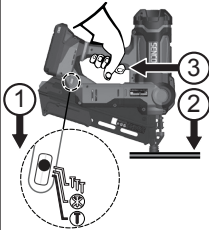

1. Press the **T** side of the selector switch for 0.5 seconds. This will be indicated by the solid green LED on the selector switch.
2. Position workpiece contact (safety) element against work surface and depress the safety.
3. Pull trigger to turn on the motor and drive a single fastener.

This mode of operation is helpful when you require precise fastener placement.



The Fusion nailer may detect a jam and reposition the driver.
The warning indicator will flash and the tool will attempt to recover.



This tool is equipped with an indicator light at the ON/OFF/MODE switch. See page 12 for detailed instructions.

Note:

When the tool is in the sequential mode, a fastener cannot be driven by pulling the trigger before activating the work piece contact element.

If the workpiece contact is activated for more than 5 seconds, the workpiece contact must be released to start over.

When the tool is in contact actuation mode, if the operator holds the trigger on for more than 3 seconds, the light will go out and the trigger must be released to start over.

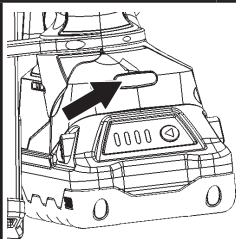

This tool is equipped with a multi-purpose light on the tool handle. The light will indicate that the electronic controls are energized.

Solid Green Light

Indicates the tool is energized and ready to drive.

This light will stay on for 10 seconds after the mode button is pressed. After this time the light will turn off but the tool is still ready to drive. Activating the trigger or work contact element will turn this light on.

If light does not turn on, look to be sure that the trigger or work contact element are free to move and not in the activated position.

Solid Red Light

Indicates the tool has detected a low battery condition or maintenance is required.

The low battery condition will first be detected by the battery. When the battery detects a low voltage condition, it will turn off the tool. Recharge the battery or replace with a fully charged battery to continue.

Inserting a fully discharged battery can cause the red light to remain on for 10 seconds. If the discharged battery voltage is lower than 12.5 volts, the tool can't be energized and no light will show. Replace with a fully charged battery.

As the battery energy is depleted, the tool may drive one final fastener and the red light will then remain on for 10 seconds.

Replace with a fully charged battery.

During sustained use, the tool may detect the low voltage condition first. Replace with a fully charged battery.

If maintenance is required, look for an issue such as a loose battery, loss of charge pressure or broken components.

Refer to the Troubleshooting Guide in the manual to help diagnose the problem.

Slow Fading Red Light

Indicates that the tool has detected an internal high temperature.

Sustained driving at a high rate can cause a high temperature condition.

Exposing the tool to sustained high temperature (rooftop, vehicle interior) can also raise the internal temperature.

Reduce drive rate or move tool to a cooler place. Reducing heat will lead to longer tool life.

Approximate 5 minute rest period will clear the high temperature light.

Approximate 30 minutes is required to return the tool to room temperature after a high temperature indication.

Note – removing the battery will not reset.

Flashing Red Light

Indicates a fastener jam.

The tool detects a jam which is usually due to a deformed nail wedged in the driver path.

Remove the battery from tool, re-insert battery and turn on tool. If tool does not return to normal operation, go to next step.

REMOVE the BATTERY

Unload all remaining fasteners in magazine. Make sure that any loose fastener from strip is also removed.

Remove the magazine with the attached allen key. 3 bolts hold the magazine in place. Remember that the three bolts do not need to be fully removed. The magazine and backplate will usually reveal the jammed fastener.

Carefully remove the jammed fastener.

Reassemble the magazine and tighten the three loosened bolts.

Attach charged battery to tool.

Load nails into magazine.

Resume normal operation.

If the wedged fastener can't be removed, return to an authorized service center where the damaged fastener can be removed. Remember that the Fusion tool contains pressurized air at all times even when the battery is removed.

TOOL OPERATION

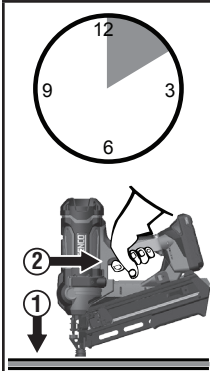

This tool is equipped with an electronic “Time-Out” feature. This tool will temporarily be disabled under any of the following conditions:

1. Workpiece contact element is depressed against the work piece, but the trigger is not pressed within approximately 5 seconds.
2. Trigger is pressed, but work piece contact element is not depressed within approximately 3 seconds. (Contact-Actuation mode only.)
 - Simply release trigger and release workpiece contact element to resume normal operation.



The tool is equipped with a fastener lockout. The tool will not fire the last 3-6 fasteners. This feature prevents unnecessary wear on the tool. When the tool locks out, load an additional strip and continue.

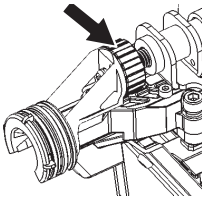

This tool is equipped with depth-of-drive dial. Turning the dial to the right will counter-sink the fastener, turning the dial to the left will leave the fastener up or raised. Drive a fastener into a scrap piece of wood to test depth.

Turning the dial in the direction shown in the image will result in the fastener driving deeper into the wood.

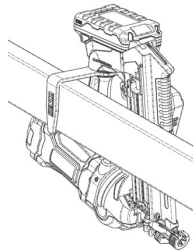
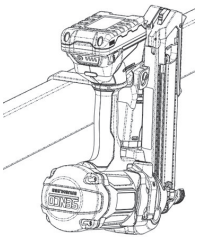

This tool is equipped with an adjustable 6 position belt hook for right and left handed operators. The hook will safely support the tool when hanging from joists and rafters.

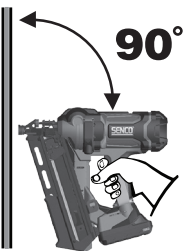

Whenever possible, hold the tool at a right angle to the work surface.

TOOL OPERATION

Indicator LED ON-Flashing

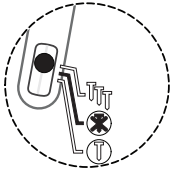

Always turn the tool off before storing. As an added protection feature, the tool will automatically turn off 60 minutes after the last activation.

When a nail jam occurs, the red light at the handle will flash red. The tool will attempt to recover.

If the jam is severe, the driver blade will lock in place by design and the red flashing light will not clear. Contact an authorized service center.

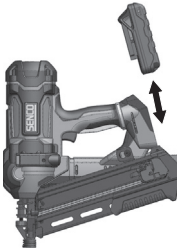

Should a minor nail jam occur:

Turn the tool off by depressing the selector switch towards either mode symbol for approximately 1 second, then **remove battery**.

Remove fasteners from magazine.

Wear safety glasses when removing magazine.

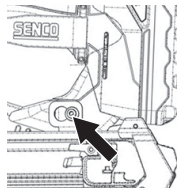
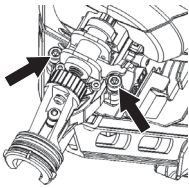

Loosen guide body screws (2) and magazine screw(1).
The three screws do not need to be completely removed

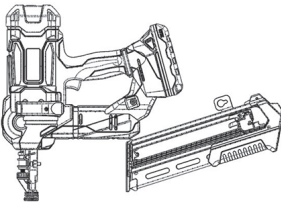

Point nose of tool away from self and others.

Separate magazine from tool body.

Do not push on the driver with any force or use a hammer to strike the driver while it is visible.

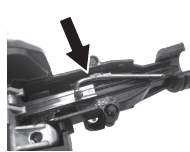

Remove jammed fastener with a pliers or screwdriver. Attach the magazine and tighten screws.

Remember! The Fusion tool is charged with compressed air in a factory sealed chamber.

Do not tamper with the drive assembly.

BATTERY CHARGING

1. Place battery pack in charger.
2. Align raised ribs on battery pack with groove in charger.
3. Press down on battery pack to be sure contacts on battery pack engage properly with contacts in charger. When properly connected, the red light will turn on. Red flashing light indicates fast charging mode.
4. Red and green light flashing indicates defective battery pack. Return battery pack to your nearest SENCO Authorized Service Center for inspection or replacement.
5. Solid red light indicates that the battery is charging.
6. When your battery pack becomes 80% charged, the red light will stay on and the green light will flash. When battery pack is fully charged, the red light will turn off and the green light will turn on.
7. After normal usage, 1 hour of charge time is required to be fully charged. A maximum charge time of 1 hour or less is required to recharge a completely discharged battery pack.
8. The battery pack will become slightly warm to the touch while charging. This is normal and does not indicate a problem.

The battery pack houses 4 colored LED lights. These LEDs indicate the state of charge and possible problems inside the battery pack.





Mode	Battery Pack Inserted?	Power 	Charging/Full 	Condition	Evaluate 	Temp.Delay 	Error 
Standby/Power	No	Fade	X	X	X	X	X
Standby Full	Yes	Fade	Fade	Ready for Use	X	X	X
Charging	Yes	Solid Green	Flashing Green	<80%	X	X	X
Fully Charged	Yes	Fading Green	Fading Green	100%	X	X	X
Evaluating	Yes	Solid Green	X	Measuring	Flash Orange	X	X
*Temp Delay	Yes	Solid Green	X	Hot/Cold	X	Flash Orange	X
Defective	Yes	Solid Green	X	Damaged	X	X	Solid Red

Figure 2 - Battery Charge Level Lights

Press raised red button on battery pack to check charge:

- Red Flashing = 0-15% Charge
- Red On = 16-25% Charge
- Red and Orange On = 26-50% Charge
- Red, Orange, and Green On = 51-75% Charge
- All On = 76-100% Charge

Tips for maintaining maximum battery life:

- Charge the battery pack before it is completely discharged.
- Always stop tool operation and charge the battery when you notice less tool power.
- Never recharge a fully charged battery.
- Overcharging shortens the battery service life.



Battery Disposal

- To preserve natural resources, please recycle or dispose of properly. This product contains Li-Ion. Local state or federal laws may prohibit disposal of Li-Ion batteries in ordinary trash.
- Consult your local waste authority for information regarding available recycling and/or disposal options.
- For more information on battery recycling call 1-800-8BATTERY.

Maintenance

Read section titled “Safety Warnings” before maintaining tool.

1. With battery removed, make daily inspection to ensure free movement of nosepiece and trigger. Do not use tool if nosepiece or trigger sticks or binds.
2. Lubrication of the feed system is not necessary. **DO NOT OIL.**
3. Wipe tool clean daily and inspect for wear, especially the bit and nosepiece. Replace as necessary.

⚠️ WARNING Repairs other than those described here should be performed only by trained, qualified personnel. Contact SENCO for information at 1-800-543-4596.

Accessories

SENCO offers a full line of accessories for your SENCO tools, including:

- Battery
- Belt Hook
- Battery Charger
- Storage Bag
- Safety Glasses
- Extended Magazine

For more information or a complete illustrated catalogue of SENCO accessories, ask your representative.

Fastener Specifications

20 Degree

SENCO Fastener Code	A	
	inches	mm*
GL**	2	50
	2-3/8	60
GD**	2	50
	2-3/8	60
HD	2-1/2	65
	3	75
HL	3-1/4	83
	3	75
KD	2-1/2	65
	3	75
	3-1/4	83
	3-1/2	90

* Rounded to nearest 5mm

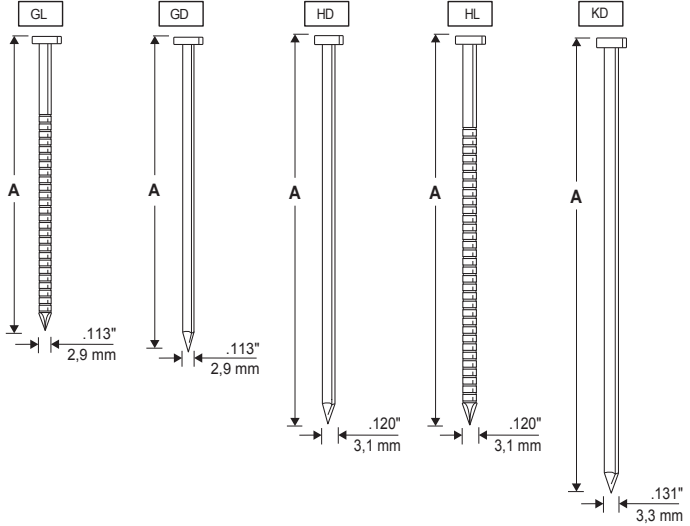

Technical Specifications

	20 Degree
Voltage	18 volts Li-ion - 3 Ahr
Weight	9.96 lbs. (without battery)
Height	14.4 inches
Length	14.6 inches
Width	4.7 inches
Recommended Drive Rate	500/Hr
Fastener Capacity	Single Strip
Fastener Range	2" - 3 1/2"
Collation Range	20 Degree
Indicator Light	Battery condition, tool temperature, maintenance, jam
Recharge Time	1 hour max., 30 minutes at 75% capacity

Troubleshooting

Problem/Symptom	Probable Cause	Corrective Action
Pressing mode switch does not result in green light.	Check battery.	Remove and reattach.
	PCB is not energized.	Pull trigger once to energize board. Then choose mode selector.
	Electronic components damaged.	Return to an authorized service center.
Red light on.	Low battery.	Recharge or replace battery. Check battery connection at tool.
	Maintenance required.	Is tool power good? If tool power seems low, return to service center for pressure check
Red light flashes.	Fastener jam.	Tool will attempt to recover.
		Did fastener drive ok?
		Remove Battery
		Check if nail is blocking next fastener.
		Inspect magazine for bent nail.
	Remove magazine and inspect guide body.	
Tool does not function.	Return to service center for repair.	
Note: if tool has jammed and the mechanism initiates an automatic recovery, the tool may make a series of clicks as it repositions the driver. This is normal.		
Red light fades every 1.4 seconds.	Internal high temperature.	Allow tool to cool at least 15 minutes. Tool will completely cool in 30 minutes.
Tool will not start or runs slowly.	Battery is discharged or has dead cell.	Replace or recharge battery.
	Workpiece contact element is jammed.	Remove battery, then inspect tool to assure free movement of workpiece contact element.
	Workpiece contact element or trigger switches are damaged.	Return tool to authorized SENCO service representative.

TROUBLESHOOTING

Tool does not drive fastener to desired depth.	Improper depth-of drive setting.	Refer to operators manual for proper adjustment.
	Tool not pressed firmly against the workpiece.	Hold tool firmly in place when driving fastener.
	Drive application is too rigorous.	Refer to operators manual for appropriate applications.
	Pressure loss.	Return tool to authorized SENCO service representative.
Tool runs but will not drive fastener.	Battery is discharged or has a dead cell.	Recharge or replace with fresh battery.
	Nail jam in guidebody.	Refer to operators manual for jam-clearing instructions.
	Mechanism requires repair.	Return tool to authorized SENCO service representative.
	Tool is overheated.	Allow tool to cool and insert fresh battery.
	Driver tip not located above fastener.	Recharge battery and allow tool to automatically retract driver.
Poor feed/ tool jamming.	Debris build-up in mechanism.	Clean tool, clean magazine or install Parts Kit.
	Driver tip not located above fastener.	
Broken or worn driver.		Return tool to authorized SENCO service representative.
Tool does not fully return.	Weak battery.	Recharge battery and allow tool to automatically retract driver.

Ensuring the long life of your Cordless Finish tool

Welcome to SENCO's family of products. SENCO brings 50 years of commitment to our customers and to power fastening systems. We are dedicated to making sure your tools are performing at their best, and we understand that ensuring the long life of your tools is important. Here are some operational and service tips.

- Start with fully charged batteries at the beginning of each work day.
- Set the depth of drive on your SENCO tool so fasteners are not over-driven.
- To maximize battery life, follow storage recommendations and charging recommendations in this manual.
- Keep your Cordless Nailer as clean and free of debris as possible.
- Service your SENCO tool periodically to insure your tool is productive and helping you earn money on the job. See the service guide below for recommended service intervals.

If your Cordless Nailer does require service, dedicated SENCO servicing dealers are available for you. For the location nearest you, call SENCO's Action line at 1-800-543-4596 or visit SENCO's website (www.senco.com).

Recommended service includes

- Check Electrical System
- Check Feed System
- Check Drive Track
- Add Grease to Piston and Driver

Limited Warranty SENCO® Pneumatic, DuraSpin®, Cordless Tools & Compressors

KYOCERA-SENCO Industrial Tools, Inc. ("SENCO") designs and constructs its products using the highest standards of material and workmanship. SENCO warrants to the original retail purchaser that the following products will be free from defects in material or workmanship for the warranty period specified below:

Products	New	Reconditioned
Pneumatic Tools *	Five Years	One Year
Fusion Tools	Two Years	Six Months
Gas Tools	Two Years	Six Months
Duraspin Tools	Five Years	90 Days

* = Both XP and Pro Series

Products	New	Reconditioned
Air Compressors	One Year	90 Days
Combo Kit Tools	One Year	90 Days
Multi-Blow Hand Nailers	One Year	90 Days
Stapling Hammers	One Year	90 Days

During the warranty period (which begins on the purchase date), SENCO will repair or replace, at SENCO's option and expense, any product or part that is defective in materials or workmanship after examination by a SENCO Authorized Warranty Service Centre, subject to the exceptions, exclusions and limitations described below. Any replacement product or part will carry a warranty for the balance of the warranty period applicable to the replaced product or part. A DATED SALES RECEIPT OR PROOF OF PURCHASE FROM THE ORIGINAL RETAIL PURCHASER IS REQUIRED TO MAKE A WARRANTY CLAIM. Warranty registration is also required and can be accomplished through on-line Product Registration at www.senco.com or by completing and returning the postage paid warranty registration form included with your Operator's manual/parts chart information, found inside the product carton. To make a warranty claim, you must return the product, with proper receipt/proof of purchase and return transportation charges prepaid, to a SENCO Authorized Warranty Service Centre. A list of SENCO Authorized Warranty Service Centres can be found at www.senco.com or by calling 1-800-543-4596 toll free. SENCO will perform its obligations under this warranty within a reasonable time after approval of the warranty claim.

SENCO Cordless:

- Subject to the exceptions, exclusions and limitations described below, SENCO warrants that the SENCO Cordless tool will be free from defects in materials and workmanship for two years after the purchase date.
- SENCO warrants that the batteries and chargers used with SENCO Cordless tools will be free from defects in material and workmanship for one year after the purchase date.

Warranty Exclusions

The following warranty exclusions apply:

- Normal wear parts are not covered under this warranty. Normal wear parts include, for example, isolators, drive belts, air filters, rubber o-rings, seals, driver blades, piston stops, and piston/driver assembly.
- This warranty does not cover parts damaged due to normal wear, misapplication, misuse, accidents, operation beyond the recommended speeds or voltage (electric units only), improper storage, or damage resulting from shipping.
- Products used in production/industrial applications as defined by SENCO are excluded from this warranty.
- Labour charges or loss or damage resulting from improper operation, maintenance or repairs are not covered by this warranty.

General Warranty Conditions

This warranty will be honoured only if:

- Clean, dry, regulated compressed air has been used, at air pressure not exceeding the maximum indicated on the tool casting;
- No evidence of abuse, abnormal conditions, accident, neglect, misuse or improper modifications or storage of the product; and
- No deviation from operating instructions, specifications, and maintenance schedules exists (read Operator Manual for use, specifications, and maintenance instructions).

THIS WARRANTY IS THE ONLY WARRANTY ON THE PRODUCT, AND SENCO DISCLAIMS ALL OTHER WARRANTIES. ANY IMPLIED WARRANTIES WILL BE LIMITED IN DURATION TO THE APPLICABLE WARRANTY PERIOD SPECIFIED ABOVE. SOME STATES DO NOT ALLOW LIMITATIONS ON HOW LONG AN IMPLIED WARRANTY LASTS, SO THE ABOVE LIMITATION MAY NOT APPLY TO YOU. YOUR REMEDIES ARE SOLELY AND EXCLUSIVELY AS STATED ABOVE. SENCO SHALL IN NO EVENT BE LIABLE FOR INCIDENTAL, CONSEQUENTIAL, INDIRECT, OR SPECIAL DAMAGES. SOME STATES DO NOT ALLOW THE EXCLUSION OR LIMITATION OF INCIDENTAL OR CONSEQUENTIAL DAMAGES, SO THE ABOVE LIMITATION OR EXCLUSION MAY NOT APPLY TO YOU. IN NO EVENT, WHETHER AS A RESULT OF A BREACH OF CONTRACT, WARRANTY, TORT (INCLUDING NEGLIGENCE) OR OTHERWISE, SHALL SENCO'S LIABILITY EXCEED THE PRICE OF THE PRODUCT WHICH HAS GIVEN RISE TO THE CLAIM OR LIABILITY. ANY LIABILITY CONNECTED WITH THE USE OF THIS PRODUCT SHALL TERMINATE UPON THE EXPIRATION OF THE WARRANTY PERIOD SPECIFIED ABOVE. NO EMPLOYEE OR REPRESENTATIVE OF SENCO OR ANY DISTRIBUTOR OR DEALER IS AUTHORIZED TO MAKE ANY CHANGE OR MODIFICATION TO THIS WARRANTY.

This warranty gives you specific legal rights, and you may also have other rights which vary from state to state.

Replacement of Tool Due to Natural Disaster

SENCO will replace any tool destroyed by an Act of God such as flood, earthquake, hurricane or other disaster resulting only from the forces of nature. Such a claim will be honoured provided that the original retail purchaser had previously submitted a completed warranty registration card for the tool, and then submits proof of ownership and an acceptable statement describing such Act of God documented by an insurance carrier, police department, or other official governmental source. To obtain instructions for filing a claim call 1-800-543-4596.

Customer Satisfaction

If for any reason the product does not perform to the original purchaser's satisfaction, it can be returned to the place of purchase within thirty days with dated sales receipt for a full refund of the purchase price (applies to new product sales only).

© 2019 KYOCERA-SENCO Industrial Tools, Inc.
CINCINNATI, OHIO 45244-1611 USA
www.senco.com
160101

KYOCERA SENCO Industrial Tools
8450 Broadwell Road
Cincinnati, Ohio 45244
www.senco.com

© 2020 by KYOCERA-SENCO Industrial Tools, Inc.

